

# MANUAL

Thanks for buying our product. Please read this manual carefully before installation and use as the manual said. In order to refer more information please take care of the manual.

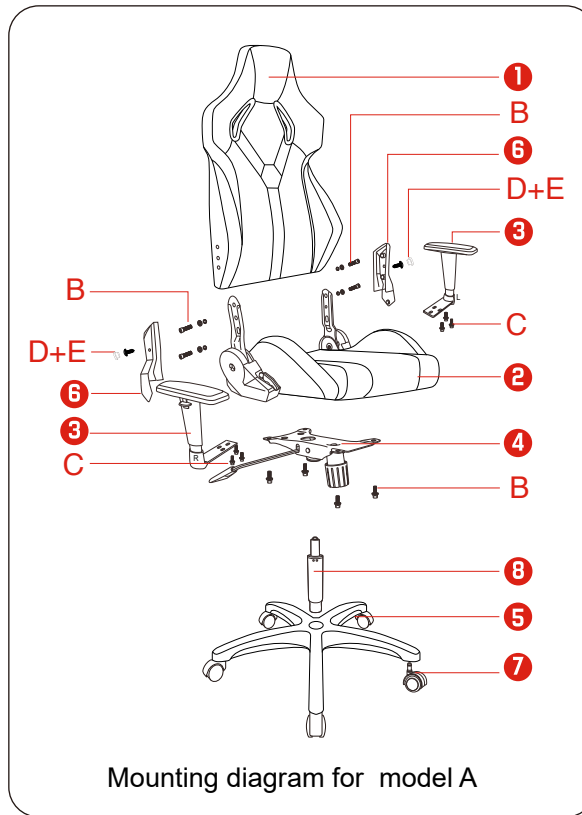

## ※ NOTES ※

### TOPSKY-079 GAMING CHAIR MANUAL

Any issues, please contact our service team with Order-ID. And if that is possible, pictures or detail of issue will be helpful for a fast way solution.

Email: [service@topskyfurniture.com](mailto:service@topskyfurniture.com)  
 Phone number: +1 725-333-1988  
 Home Page: <https://www.topskyfurniture.com/>

All office chairs purchased on TOPSKY are backed by 1-year warranty. Specifically, the warranty covers:

- ① Gas cylinder falling automatically (May need to remove gas lift from mechanism)
- ② Chair base, mechanism, arms, castors, back, frame, headrest damaged
- ③ Mechanism losing control (e.g. the back can't be fixed in position, if the chair has recline function)
- ④ Sponge foam on seat/armrest/lumbar support (if have) being collapsed by more than 50% (e.g. 2.76 inch to 1.38 inch)
- ⑤ Leather/Mesh damaged or falling apart over 1.18inch in diameter
- ⑥ Squeaky noise (May need to remove gas lift from mechanism)

\*For some issues over 1 year, we can provide paid replacement parts service. Please contact us by phone, email or official website.

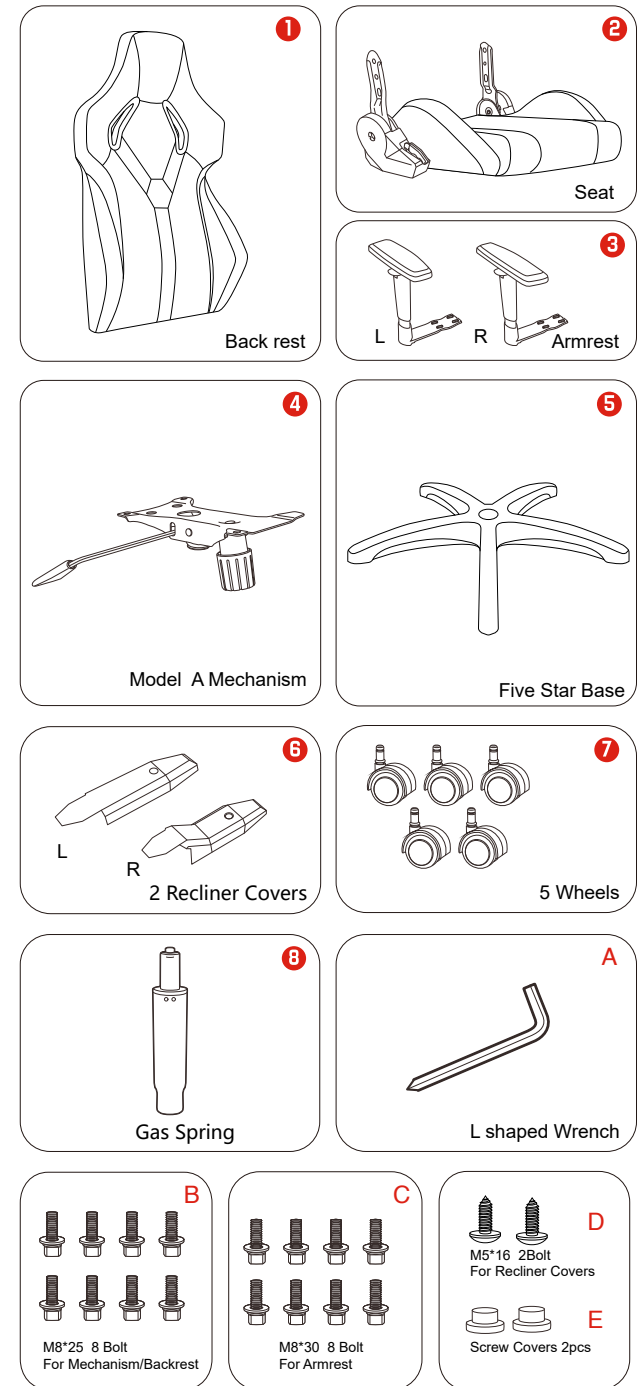

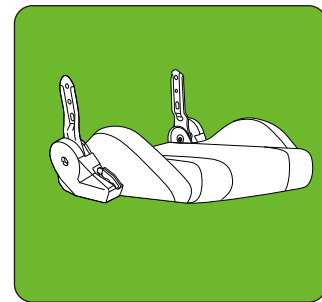
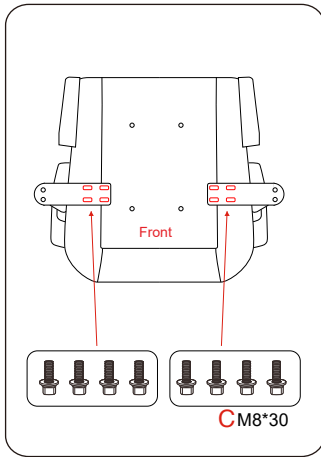

**STEP 1**  
**Lock the armrest to the seat base**  
 Put the armrest on the seat base and tighten 8pcs bolts **【C】** (M8\*30)

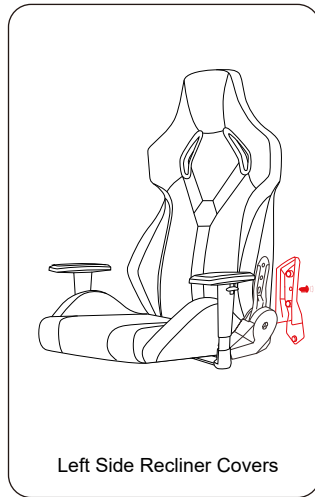

Left Side Recliner Covers

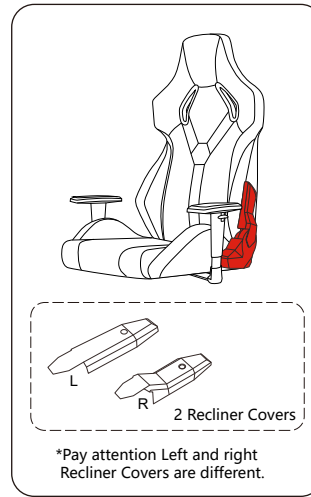

\*Pay attention Left and right Recliner Covers are different.

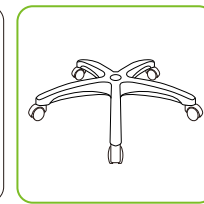
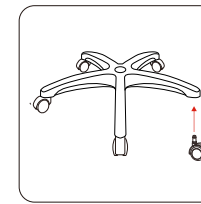

**STEP 6**  
**Install the wheel**

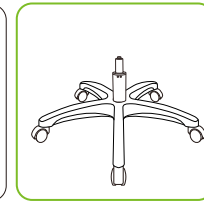
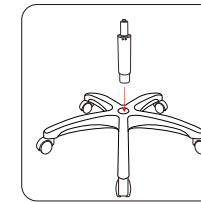

**STEP 7**  
**Install the gas spring**

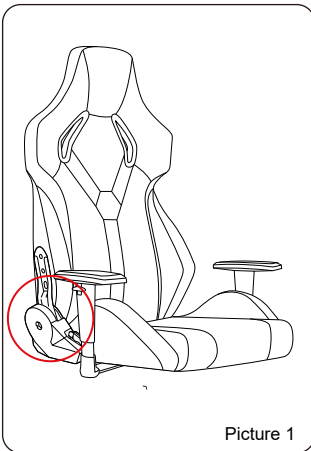
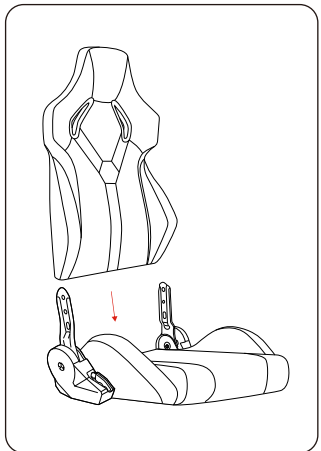

Picture 1

**STEP 2**  
**Put the back rest and seat together**  
 Put the back rest and seat together as the picture 1. Please pay attention to the red marked place (left and right sides) which need aim at the bolts holes.

**STEP 3**  
**Lock the back rest and seat**  
 Lock 4pcs bolts **【B】** (M8\*25) on the left and right side as the picture step by step.

(Begin at the right side where the tilting handle is located. Screw both bolts on the right side half way in and then screw in the two bolts on the left side. Now tighten the bolts on both sides)

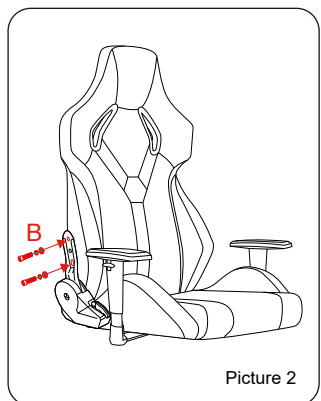

Picture 2

**STEP 4**  
**Install the recliner covers**  
 Attach the lower snap button first. Lock the Screw D(M5\*16) into the hole on the recliner cover.  
 \*Pay attention Left and right Recliner Covers are different.

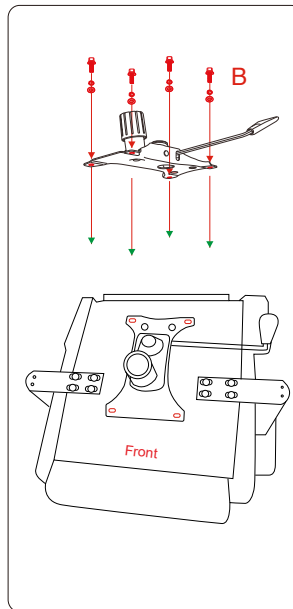

**STEP 5**  
**Install the mechanism**  
 Use 4pcs bolts **【B】** (M8\*25) to lock the Mechanism and seat together, and make sure the bolts are screwed in tight.

\*Pay attention direction of the mechanism

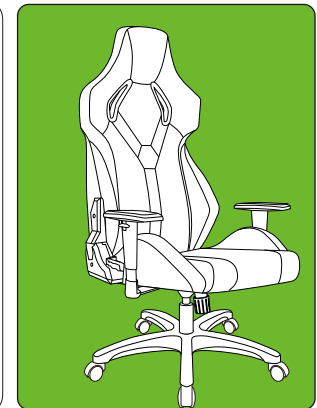
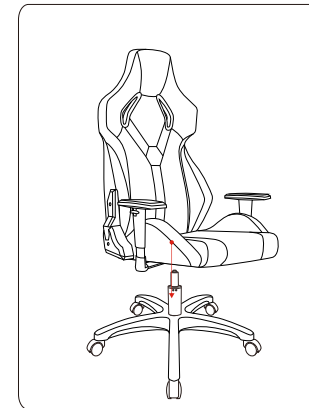
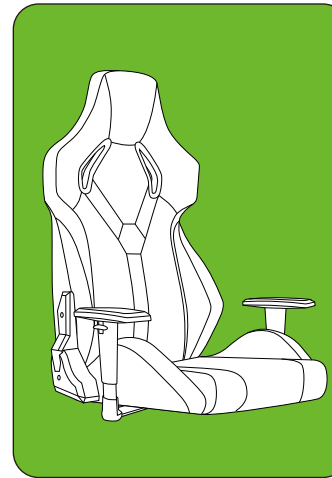

**STEP 8** **Put the chair body on the gas spring**  
 Aim at the top of gas spring and the hole of mechanism, then put the chair body down.

**Usage & Safety Instructions**



Sit in the center of the chair, with your back to the backrest.



Do not sit at the front edge of the chair.



Do not stand on the chair.



Do not use the chair with more than one person



Do not push the chair around when a person is sitting in it.



Do not push down on the backrest when a person is reclined.



Do not place all your weight on the backrest only.



Do not place your hand or fingers near the recline mechanics.